







-  Kork
-  Holz
-  Dämmung
-  Dichtung
-  Fensterrahmen
-  Silikon
-  Butylband





Patentrechtlich geschützt!

Kommission				Auftragsnr:
Oberfläche		Beschlag		
Behandlung		Sonstiges	Datum	11.2010
Maßstab:	Benennung:	CadName: wie Benennung		
1:1	Alu2Holz FIX seitlich + oben			

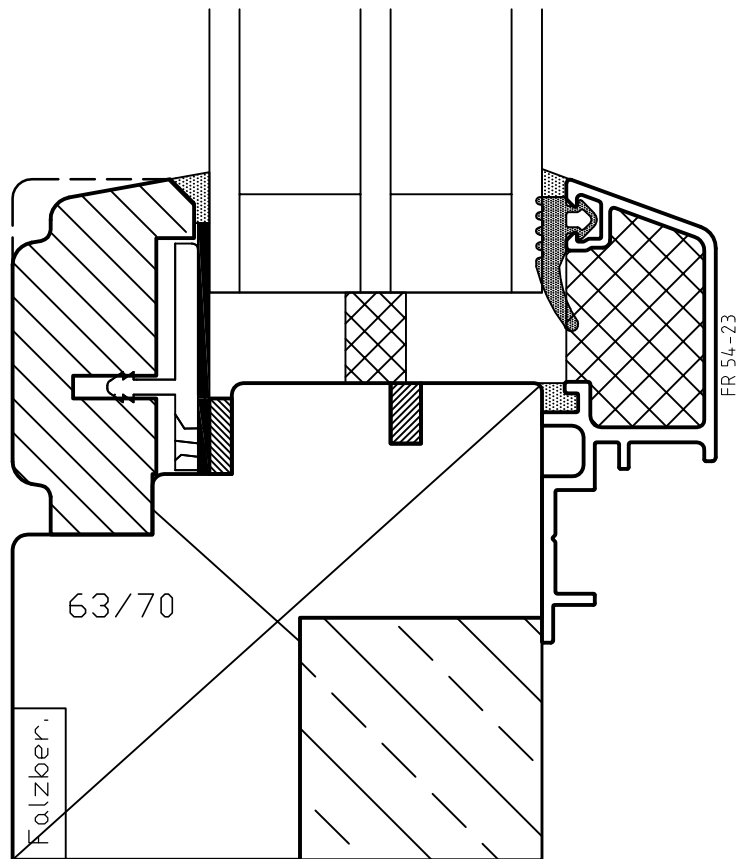
STEFANI

FENSTER, TÜREN • MÖBEL AUS DEM NENNVERTEL



-  Kork
-  Holz
-  Dämmung
-  Dichtung
-  Fensterrahmen
-  Silikon
-  Butylband





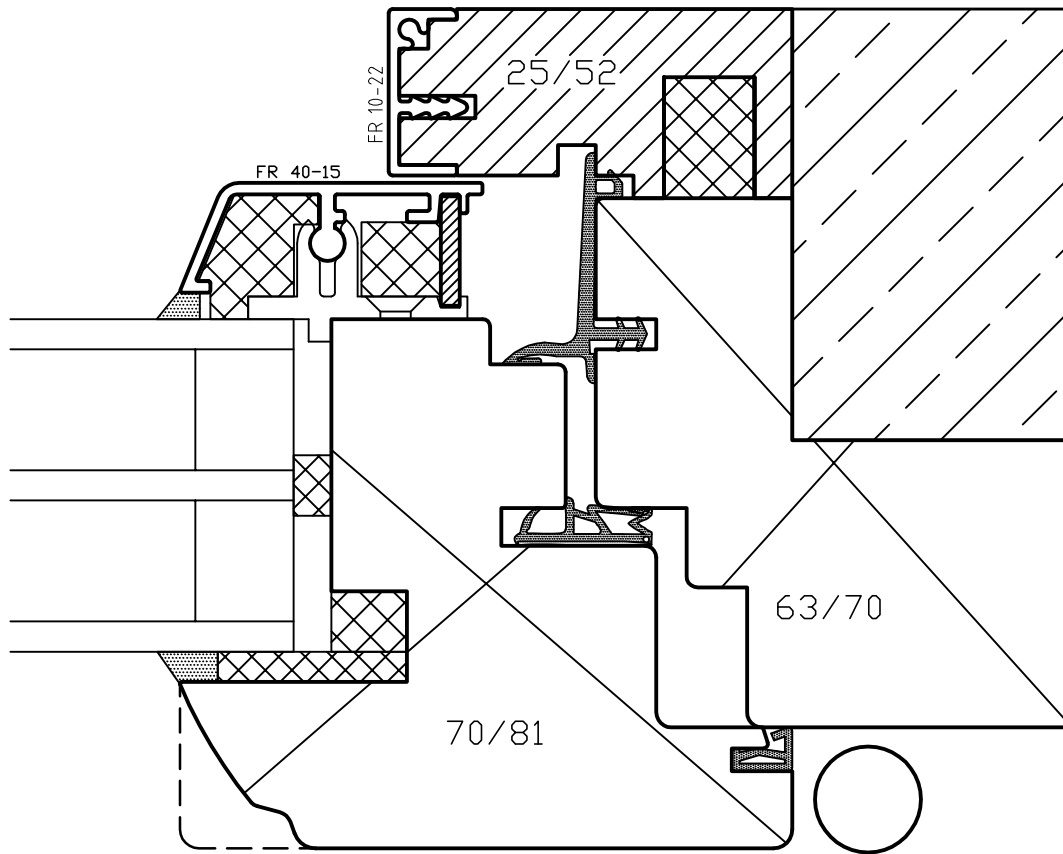

Patentrechtlich geschützt!

Kommission		Auftragsnr:	
Oberfläche		Beschlag	
Behandlung		Sonstiges	Datum 11.2010
Maßstab:	Benennung:	CadName: wie Benennung	
1:1	Alu2Holz FIX unten		

STEFANI

FENSTER, TÜREN • MÖBEL AUS DEM NENNVERTEL









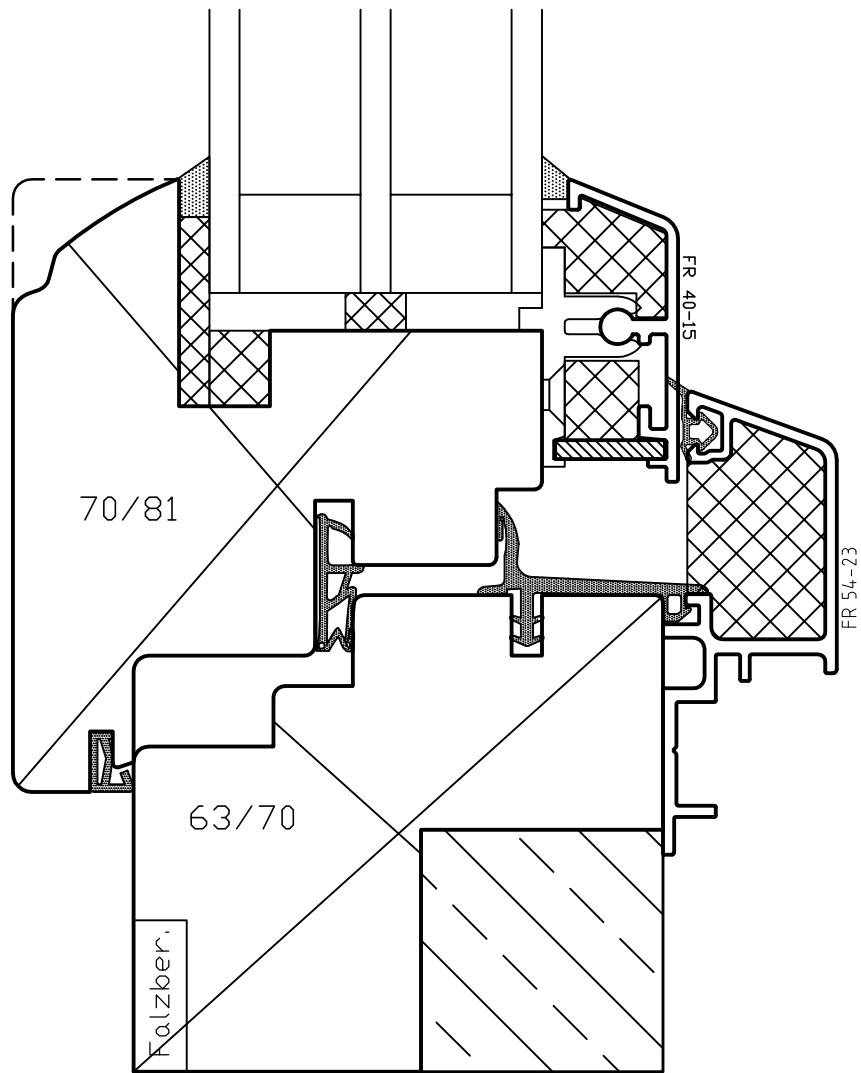

-  Kork
-  Holz
-  Dämmung
-  Dichtung
-  Fensterrahmen
-  Silikon
-  Butylband

Patentrechtlich geschützt!

Kommission				Auftragsnr:	
Oberfläche		Beschlag		Datum	11.2010
Behandlung		Sonstiges		CadName: wie Benennung	
Maßstab:	Benennung:				
1:1	Alu2Holz Flügel seitlich + oben				

STEFANI
FENSTER, TÜREN • MÖBEL AUS DEM NENNVERTEIL



-  Kork
-  Holz
-  Dämmung
-  Dichtung
-  Fensterrahmen
-  Silikon
-  Butylband





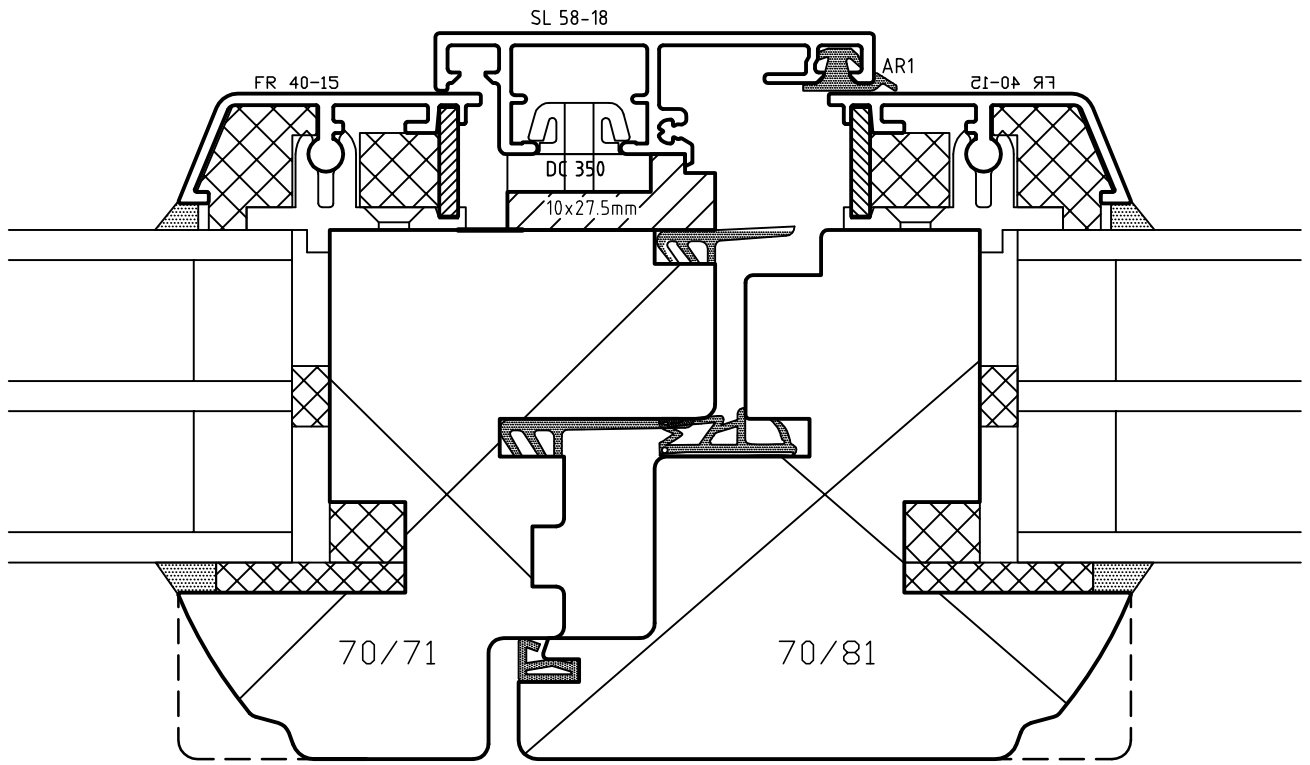

Patentrechtlich geschützt!

Kommission				Auftragsnr:	
Oberfläche		Beschlag			
Behandlung		Sonstiges		Datum	11.2010
Maßstab:	Benennung:			CadName: wie Benennung	
1:1	Alu2Holz Flügel unten				

STEFANI

FENSTER, TÜREN • MÖBEL AUS DEM NENNVERTEIL







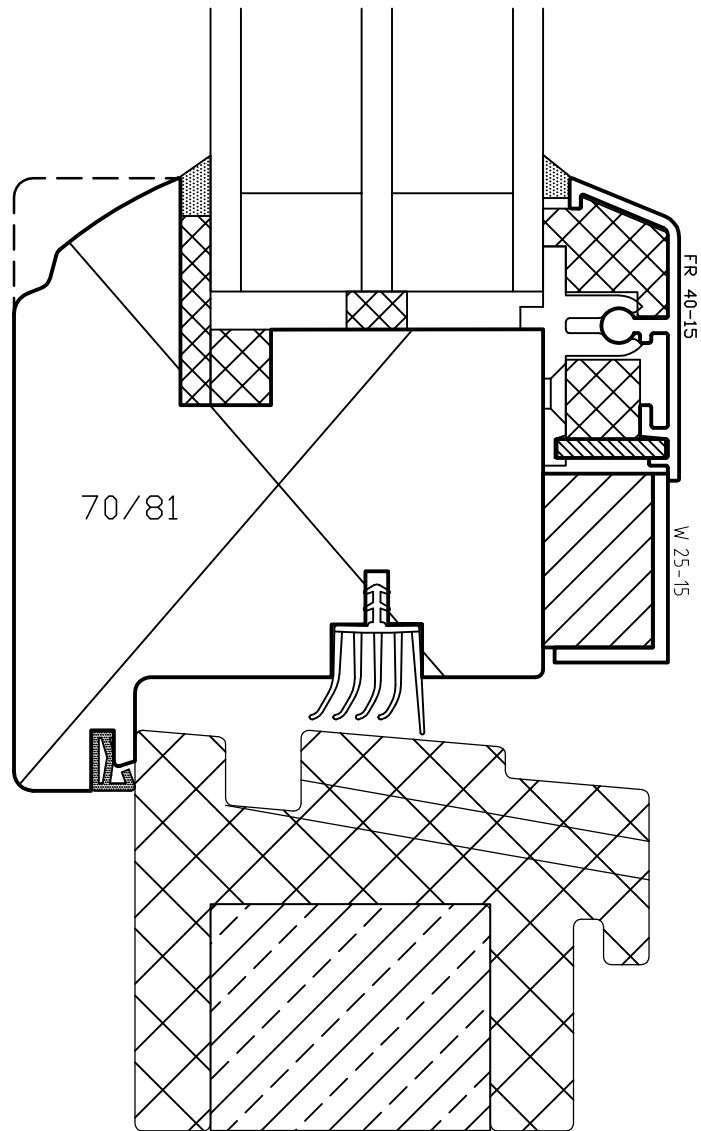

-  Kork
-  Holz
-  Dämmung
-  Dichtung
-  Fensterrahmen
-  Silikon
-  Butylband

Patentrechtlich geschützt!

Kommission			Auftragsnr:	STEFANI <small>FENSTER, TÜREN • MÖBEL AUS DEM NENNVERTEIL</small>
Oberfläche	Beschlag			
Behandlung	Sonstiges	Datum	11.2010	
Maßstab:	Benennung:	CadName: wie Benennung		
1:1	Alu2Holz Stulp schmal			



-  Kork
-  Holz
-  Dämmung
-  Dichtung
-  Fensterrahmen
-  Silikon
-  Butylband





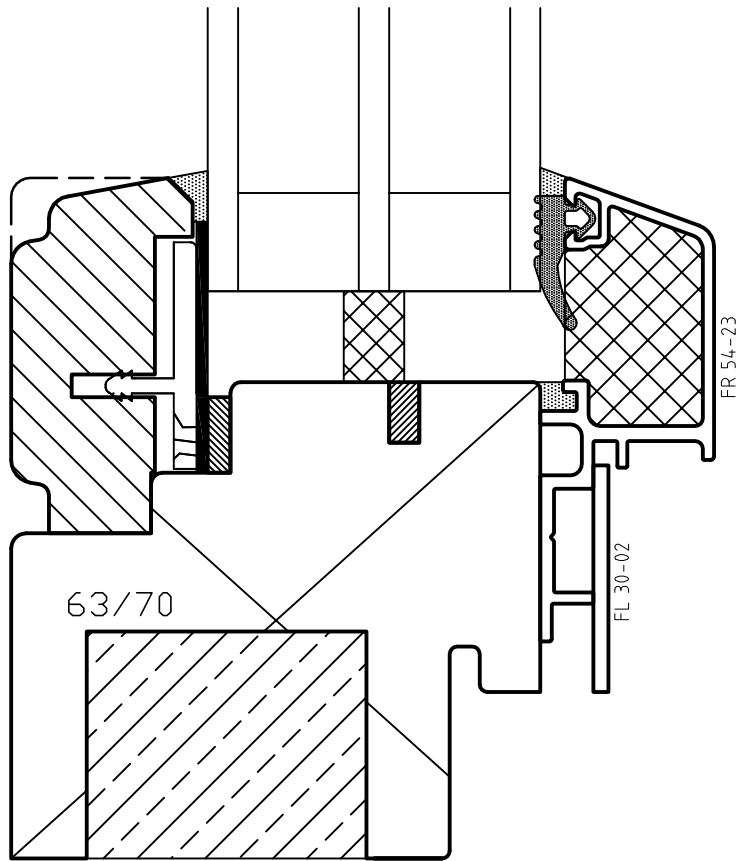

Patentrechtlich geschützt!

Kommission				Auftragsnr:	
Oberfläche		Beschlag		Datum	11.2010
Behandlung		Sonstiges		CadName:	wie Benennung
Maßstab:	Benennung:				
1:1	Alu2Holz GFK-Schwelle bei Terrassentüre				

STEFANI

FENSTER, TÜREN • MÖBEL AUS DEM WENNVERTTEL



-  Kork
-  Holz
-  Dämmung
-  Dichtung
-  Fensterrahmen
-  Silikon
-  Butylband





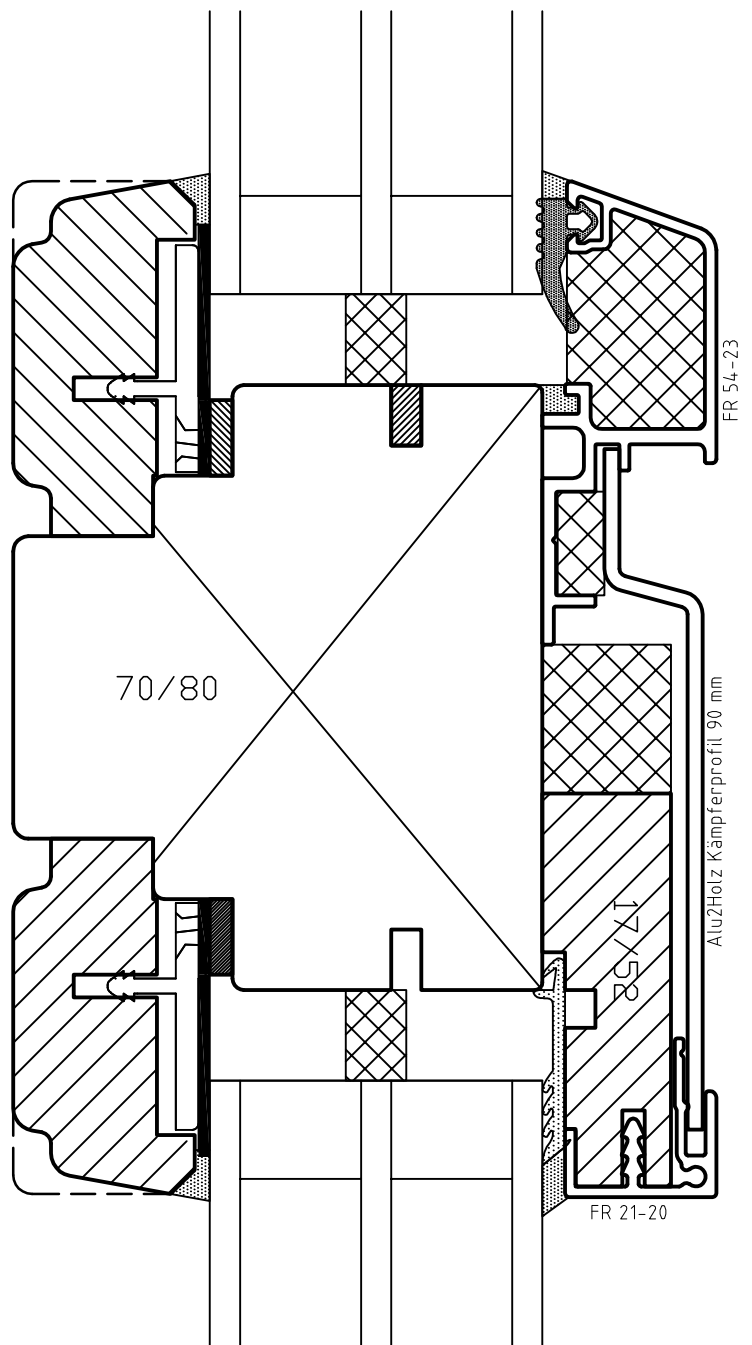

Patentrechtlich geschützt!

Kommission				Auftragsnr:	
Oberfläche		Beschlag			
Behandlung		Sonstiges		Datum	11.2010
Maßstab:	Benennung:			CadName: wie Benennung	
1:1	Alu2Holz FIX unten bei Kombi mit GFK Schwelle				

STEFANI

FENSTER, TÜREN • MÖBEL AUS DEM NENNVERTEIL



-  Kork
-  Holz
-  Dämmung
-  Dichtung
-  Fensterrahmen
-  Silikon
-  Butylband





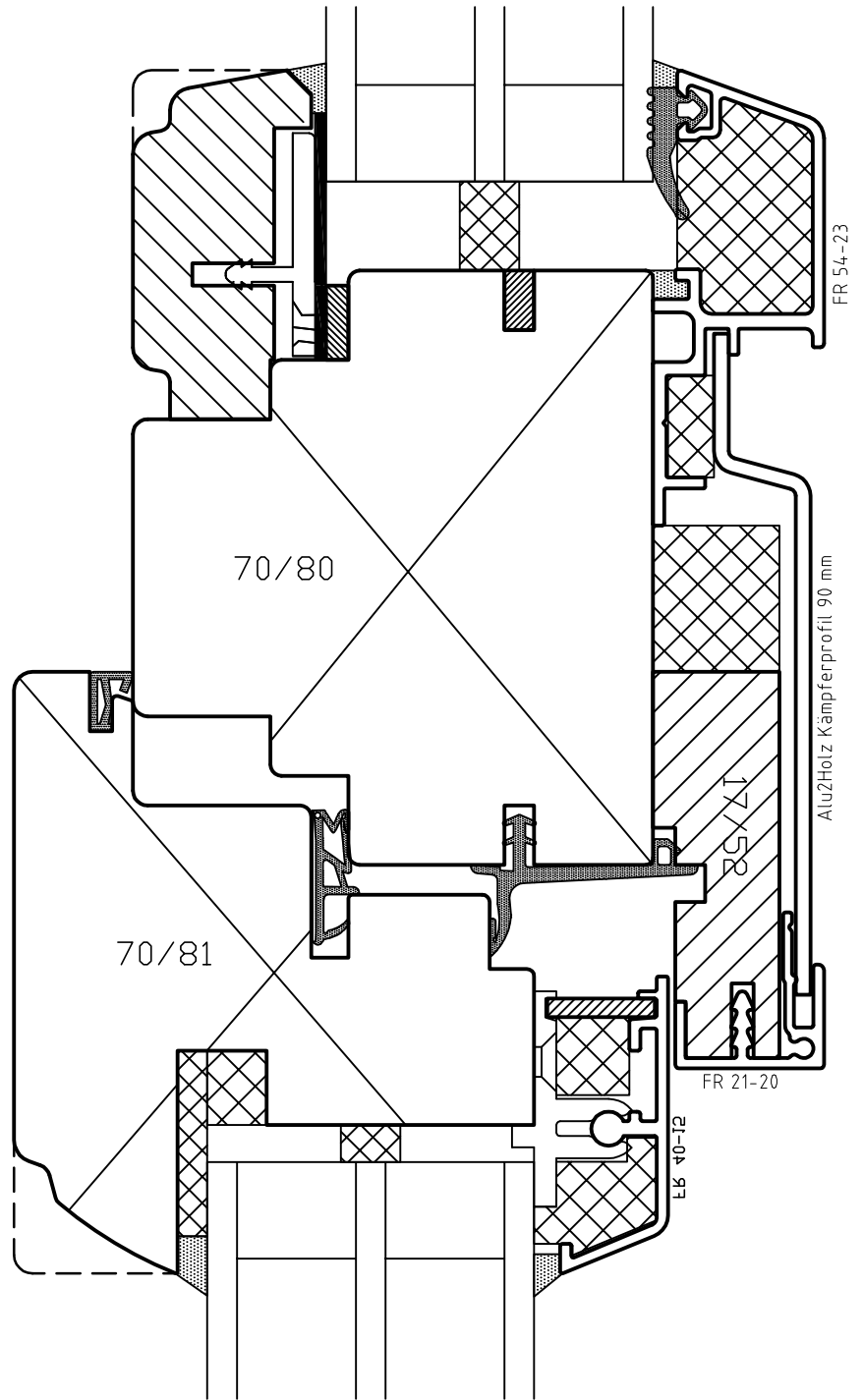

Patentrechtlich geschützt!

Kommission				Auftragsnr:	
Oberfläche		Beschlag		Datum	11.2010
Behandlung		Sonstiges		CadName:	wie Benennung
Maßstab:	Benennung:				
1:1	Alu2Holz Kämpfer Fix-Fix				

STEFANI

FENSTER, TÜREN • MÖBEL AUS DEM NENNVERTEIL



-  Kork
-  Holz
-  Dämmung
-  Dichtung
-  Fensterrahmen
-  Silikon
-  Butylband





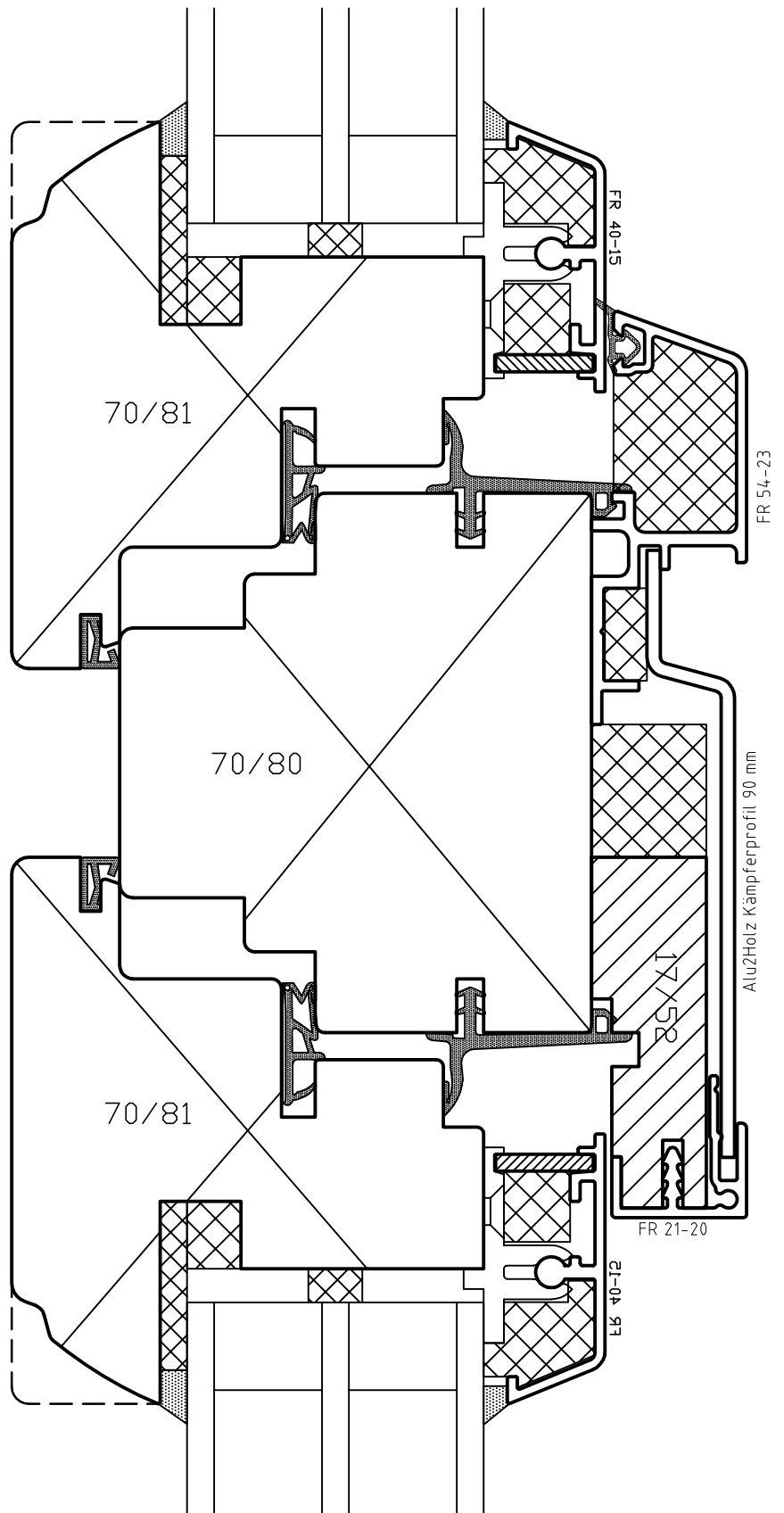

Patentrechtlich geschützt!

Kommission				Auftragsnr:	
Oberfläche		Beschlag		Datum	11.2010
Behandlung		Sonstiges		CadName: wie Benennung	
Maßstab:	Benennung:		<h1 style="margin: 0;">Alu2Holz Kämpfer Fix-Flügel</h1>		
1:1					

STEFANI

FENSTER, TÜREN • MÖBEL AUS DEM NENNVERTEL







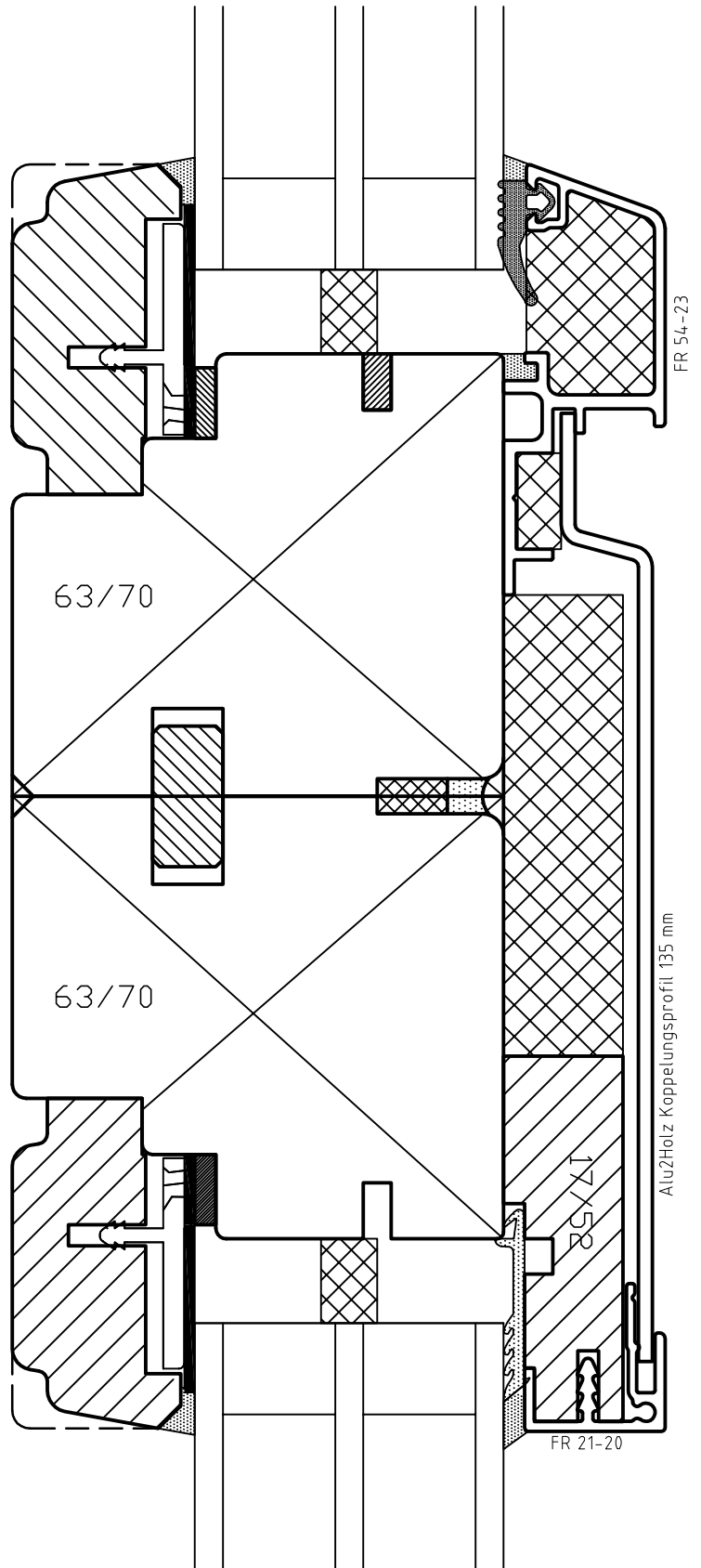

-  Kork
-  Holz
-  Dämmung
-  Dichtung
-  Fensterrahmen
-  Silikon
-  Butylband

Patentrechtlich geschützt!

Kommission				Auftragsnr:	STEFANI
Oberfläche	Beschlag				
Behandlung	Sonstiges	Datum	11.2010		
Maßstab:	Benennung:	CadName: wie Benennung			
1:1	Alu2Holz Kämpfer Flügel-Flügel				FENSTER, TÜREN • NÖBEL AUS DEM NENNVERTEL



-  Kork
-  Holz
-  Dämmung
-  Dichtung
-  Fensterrahmen
-  Silikon
-  Butylband





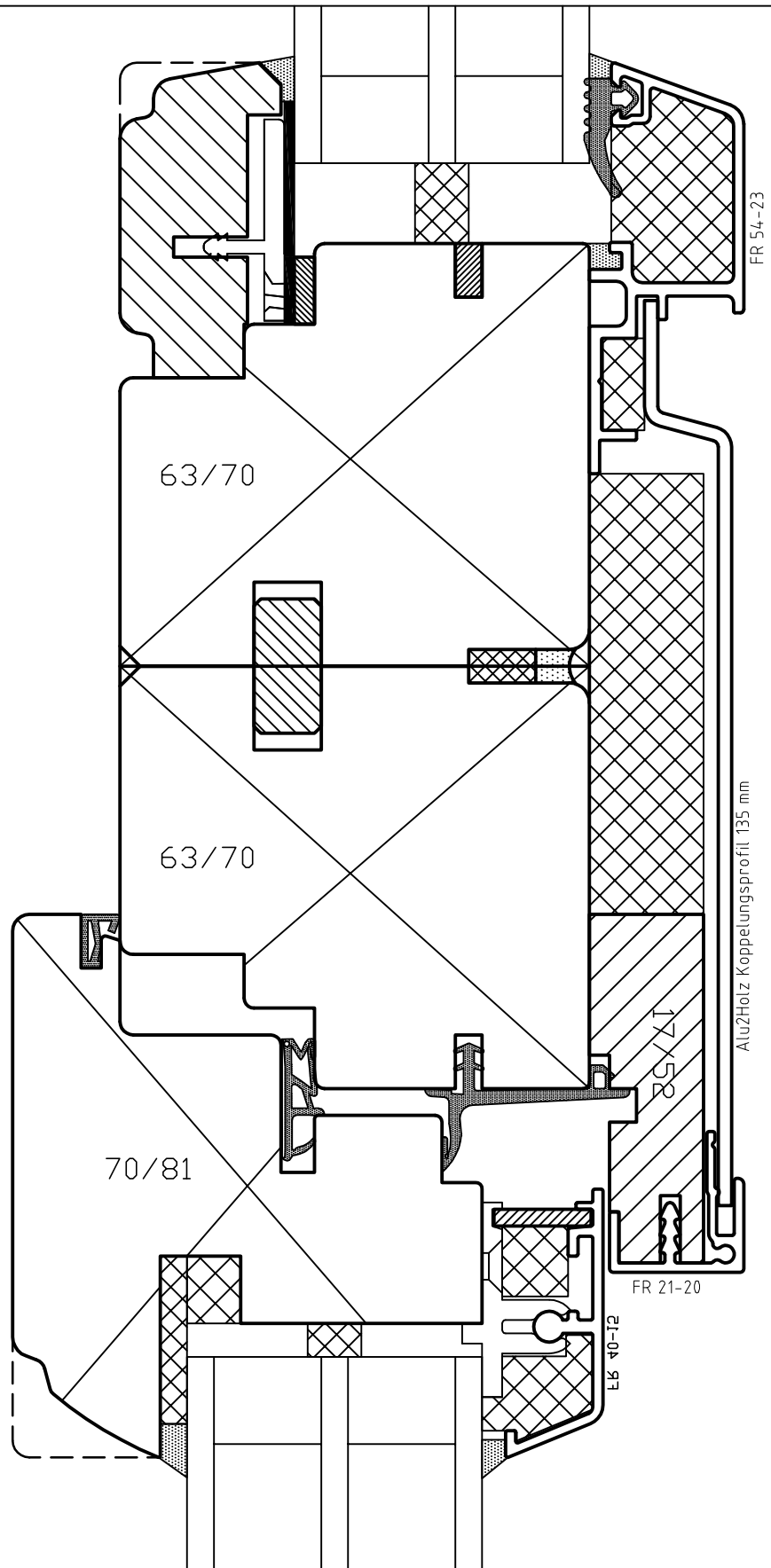

Patentrechtlich geschützt!

Kommission			Auftragsnr:
Oberfläche	Beschlag		
Behandlung	Sonstiges	Datum	11.2010
Maßstab:	Benennung:	CadName: wie Benennung	
1:1	Alu2Holz Koppelung horizontal Fix-Fix		

STEFANI

FENSTER, TÜREN • NÖBEL AUS DEM NENNVERTEL



-  Kork
-  Holz
-  Dämmung
-  Dichtung
-  Fensterrahmen
-  Silikon
-  Butylband





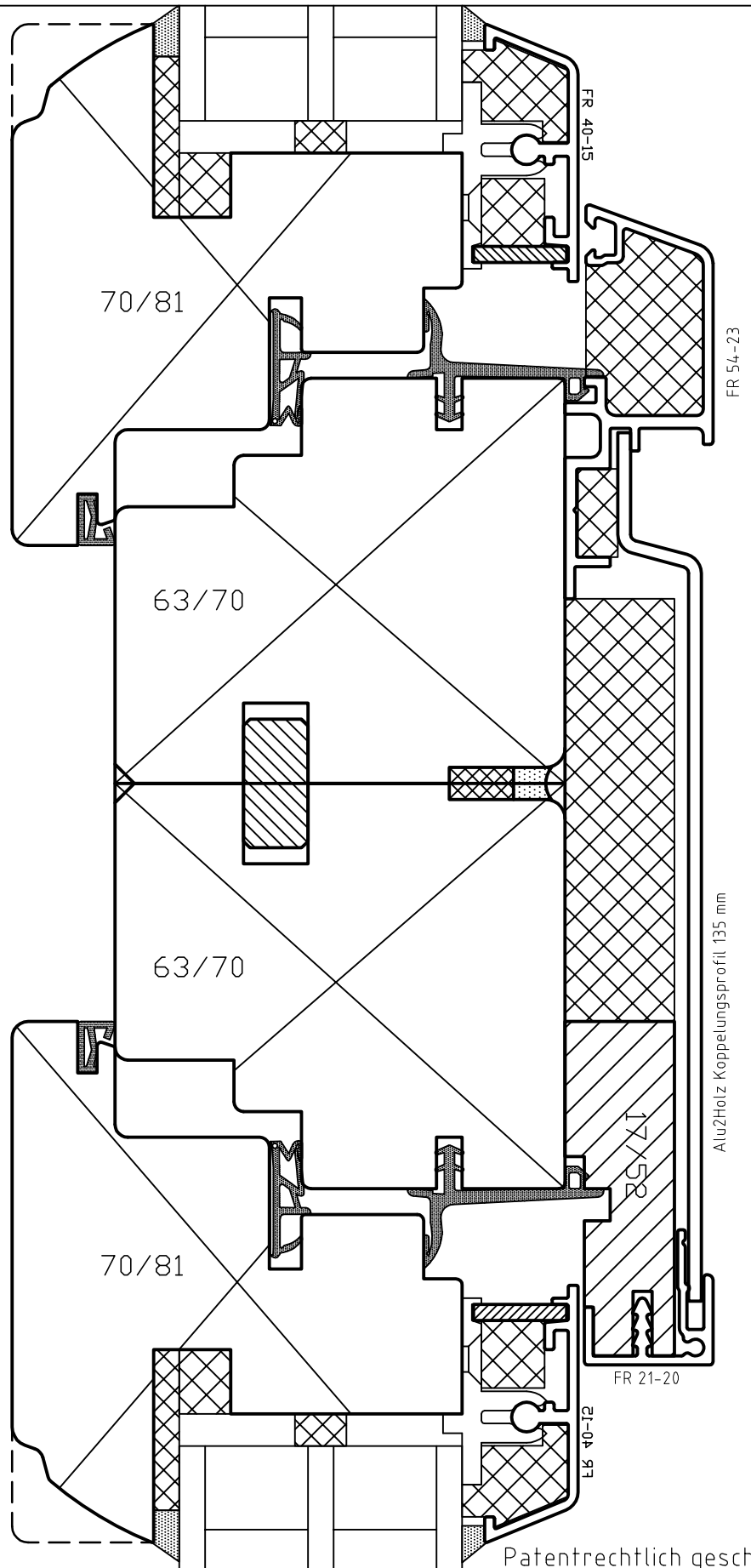

Patentrechtlich geschützt!

Kommission			Auftragsnr:
Oberfläche	Beschlag		
Behandlung	Sonstiges	Datum	11.2010
Maßstab:	Benennung:	CadName: wie Benennung	
1:1	Alu2Holz Koppelung horizontal Fix-Flügel		

STEFANI

FENSTER, TÜREN • MÖBEL AUS DEM NENNVERTEIL



-  Kork
-  Holz
-  Dämmung
-  Dichtung
-  Fensterrahmen
-  Silikon
-  Butylband

Patentrechtlich geschützt!





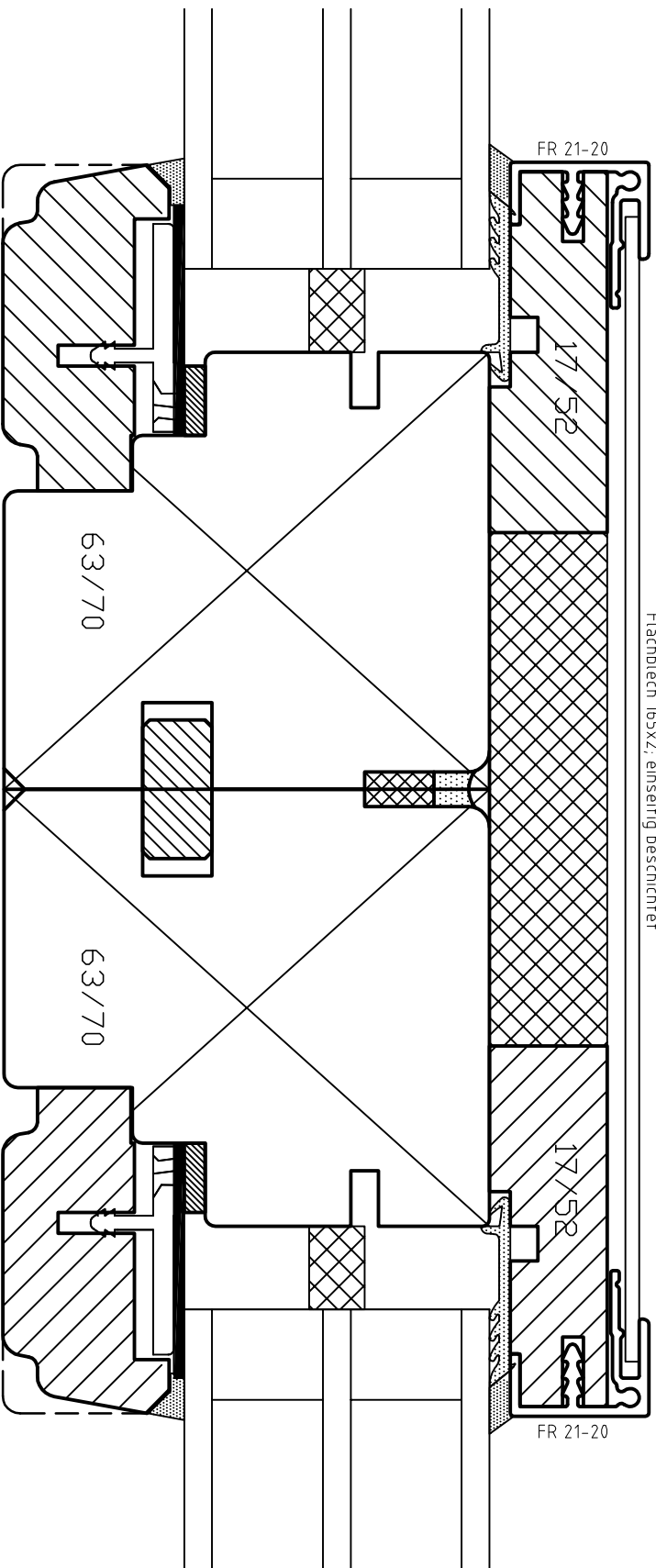

Kommission				Auftragsnr.	
Oberfläche		Beschlag			
Behandlung		Sonstiges		Datum	11.2010
Maßstab:	Benennung:			CadName:	wie Benennung
1:1	Alu2Holz Koppelung horizontalt Fix-Flügel				

STEFANI

FENSTER, TÜREN • MÖBEL AUS DEM WENNERTTEL



Flachblech 165x2, einseitig beschichtet

-  Kork
-  Holz
-  Dämmung
-  Dichtung
-  Fensterrahmen
-  Silikon
-  Butylband

Patentrechtlich geschützt!

Kommission		Auftragsnr.:	
Oberfläche		Beschlag	
Behandlung		Sonstiges	
Maßstab:	1:1	Benennung:	Koppelung vertikal Fix-Fix
CodName: wie Benennung		Datum: 11.2010	





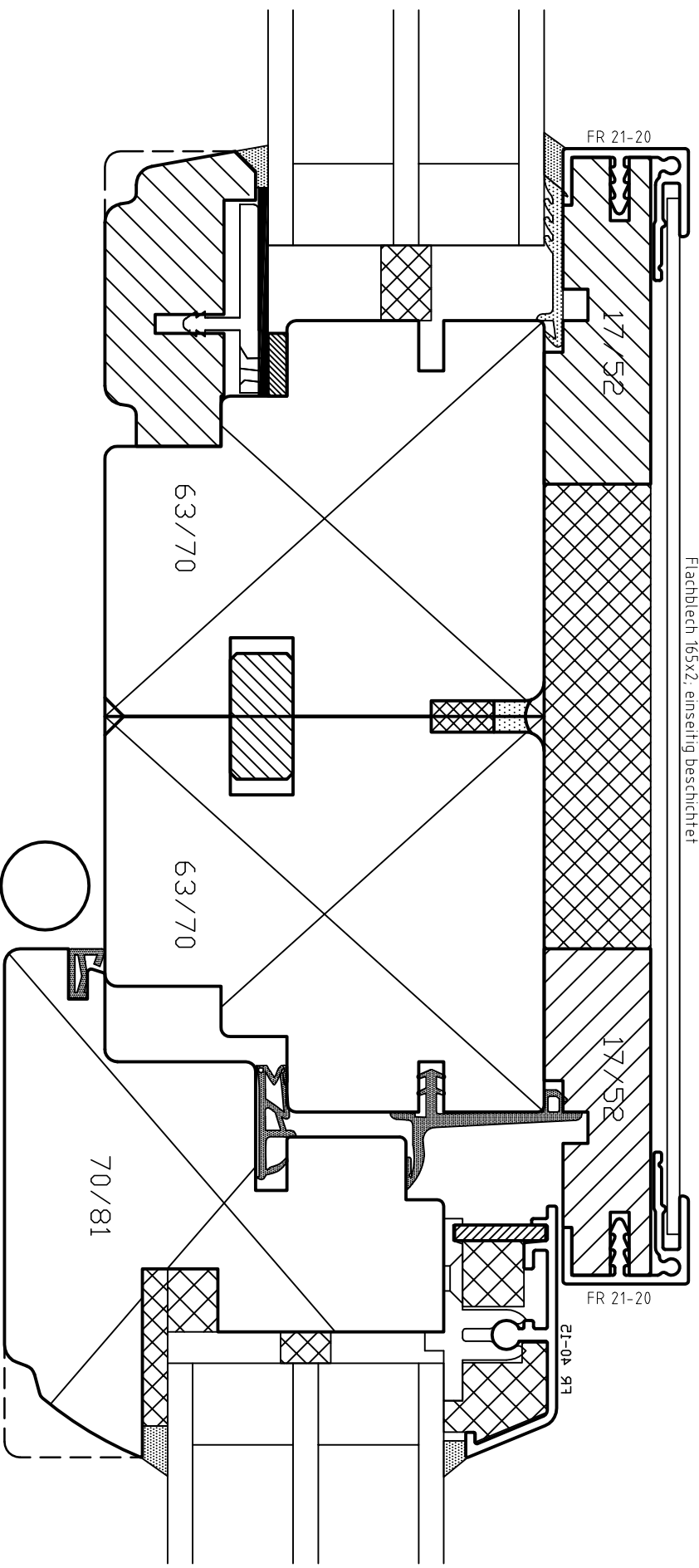

STEFFAN

FENSTER, TÜREN • WÄNDE, AUS SICHERHEITSTEILE



Flachblech 165x2, einseitig beschichtet

Patentrechtlich geschützt!

-  Kork
-  Holz
-  Dämmung
-  Dichtung
-  Fensterrahmen
-  Silikon
-  Butylband

Kommission		Auftragsnr.:	
Oberfläche		Beschlag	
Behandlung		Sonstiges	
Maßstab:	Benennung:	CodName: wie Benennung	
1:1	Koppelung vertikal Fix-Flügel	Datum: 11.2010	





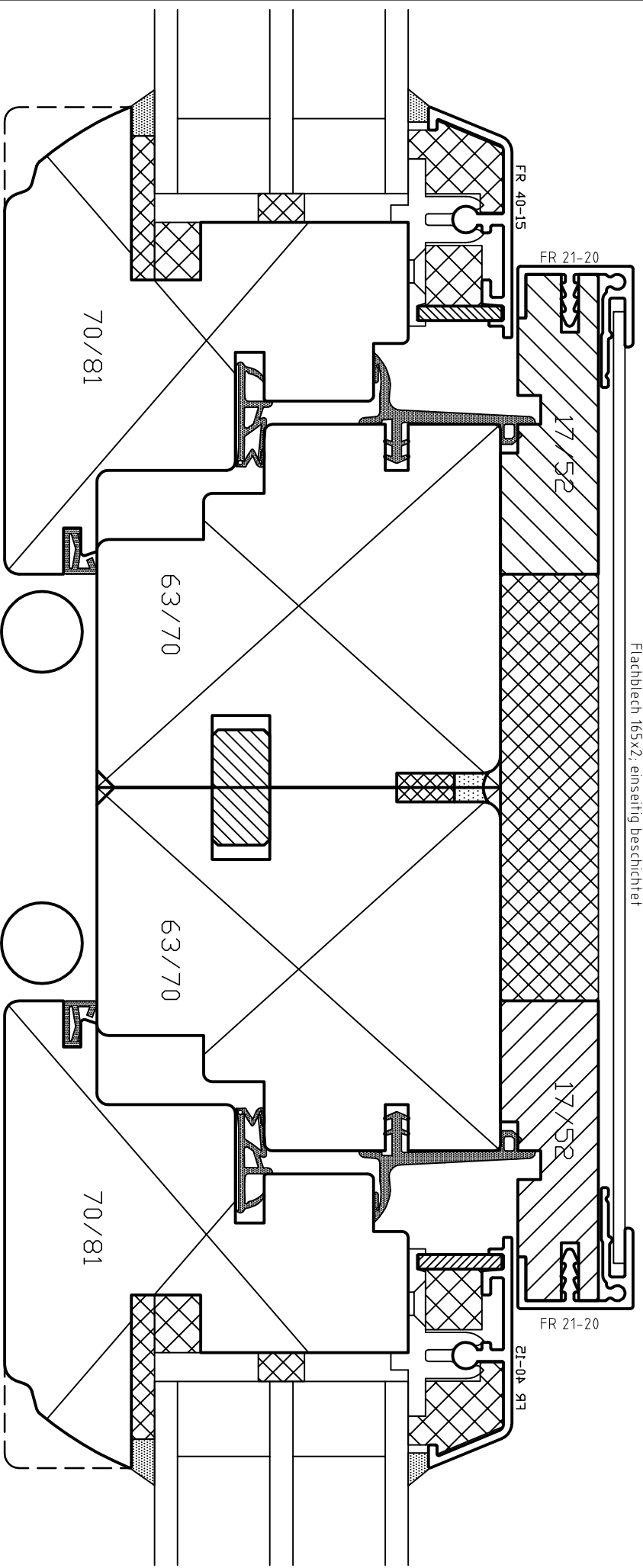

STEFFAN

FENSTER, TÜREN • WÄNDE AUS DORN KUNSTSTOFF









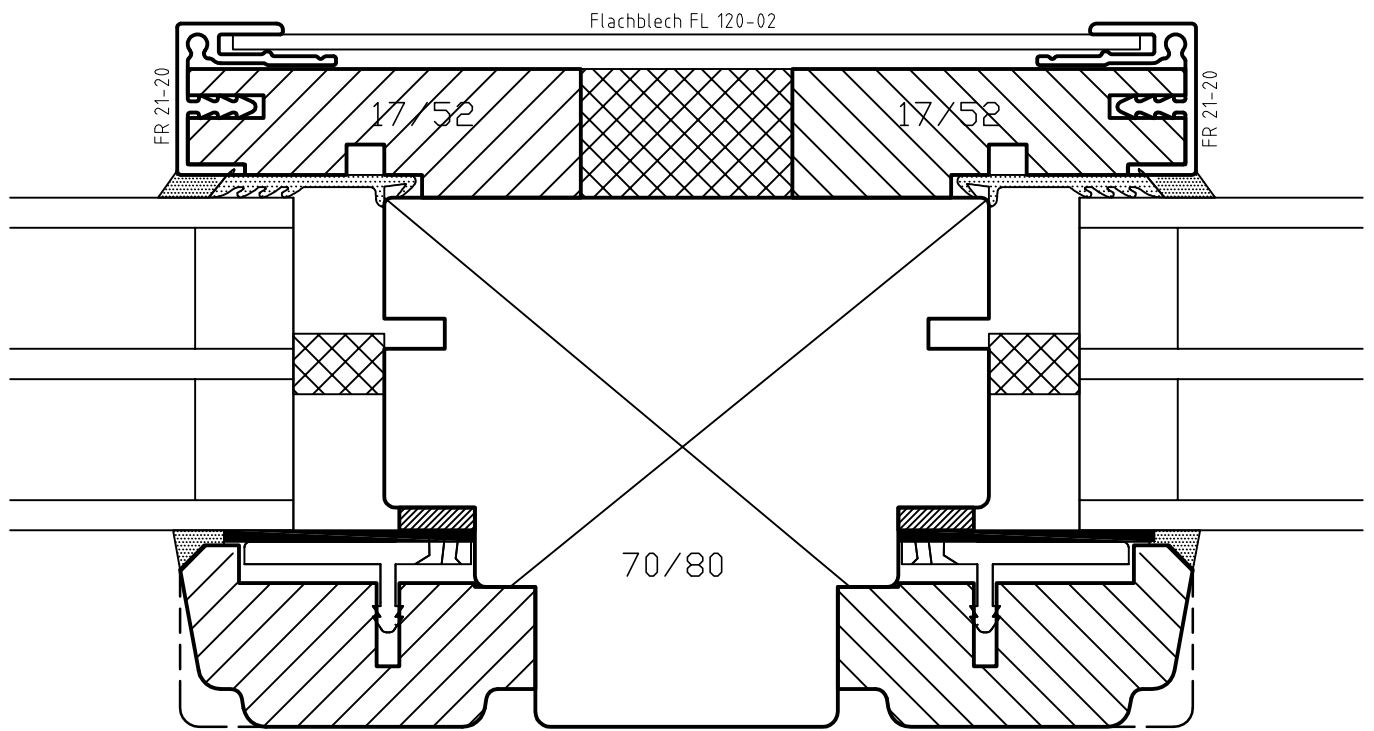

Flachblech 165x2; einseitig beschichtet

Patentrechtlich geschützt!

-  Kork
-  Holz
-  Dämmung
-  Dichtung
-  Fensterrahmen
-  Silikon
-  Butylband

Kommission		Auftragsnr.:	
Oberfläche		Beschlag	
Behandlung		Sonstiges	
Maßstab: 1:1		Datum: 11.2010	
Benennung:		CodName: wie Benennung	
Koppelung vertikal Flügel – Flügel			
STEFFAN			
FENSTER · TÜREN · WÄNDE AUS DICH KUNSTWERKE			





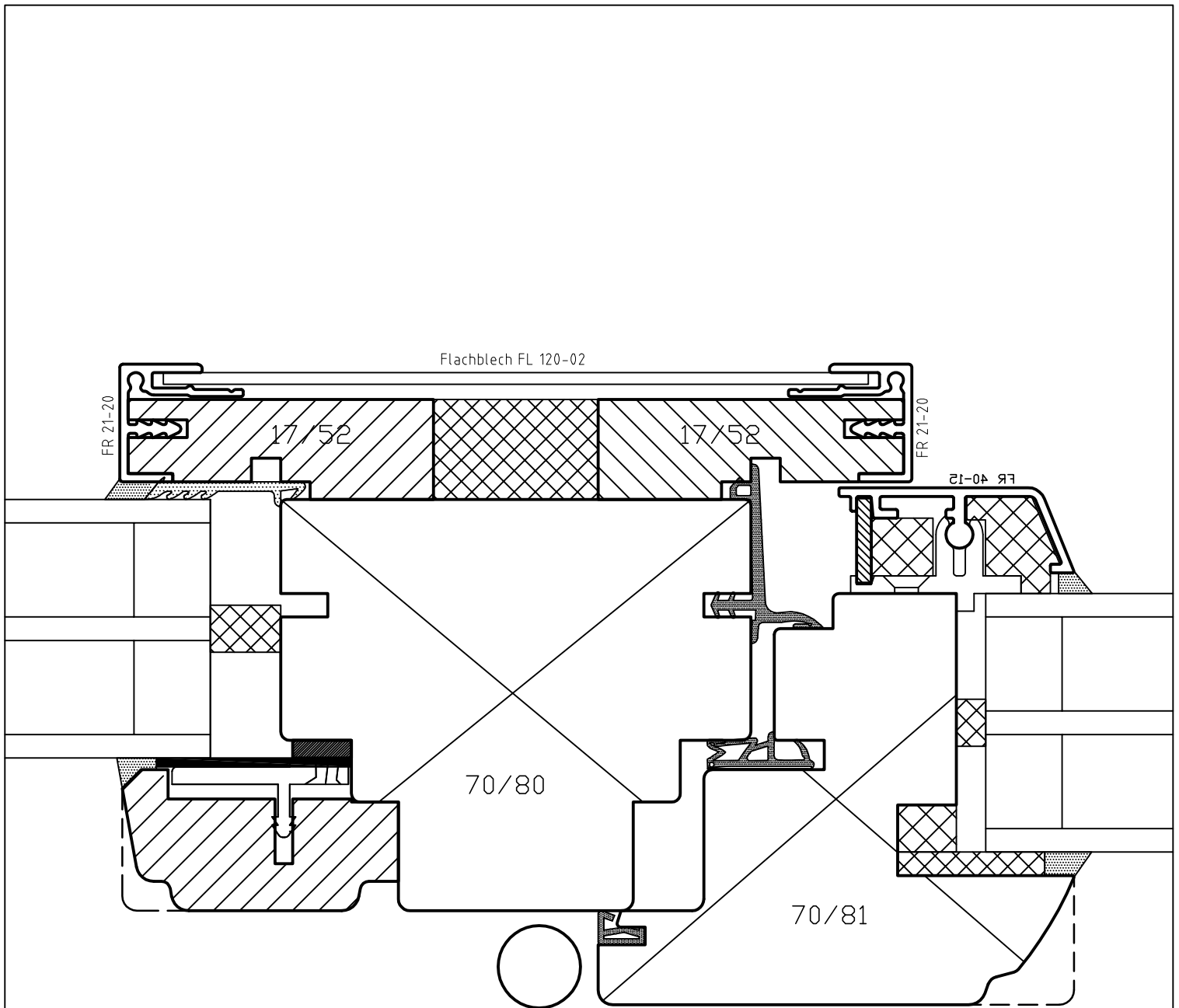

-  Kork
-  Holz
-  Dämmung
-  Dichtung
-  Fensterrahmen
-  Silikon
-  Butylband

Patentrechtlich geschützt!

Kommission				Auftragsnr:	STEFANI
Oberfläche	Beschlag				
Behandlung	Sonstiges	Datum	11.2010		
Maßstab:	Benennung:		CadName: wie Benennung		
1:1	Alu2Holz Setzholz Fix-Fix				FENSTER, TÜREN • MÖBEL AUS DEM NENNVERTEIL



-  Kork
-  Holz
-  Dämmung
-  Dichtung
-  Fensterrahmen
-  Silikon
-  Butylband

Patentrechtlich geschützt!



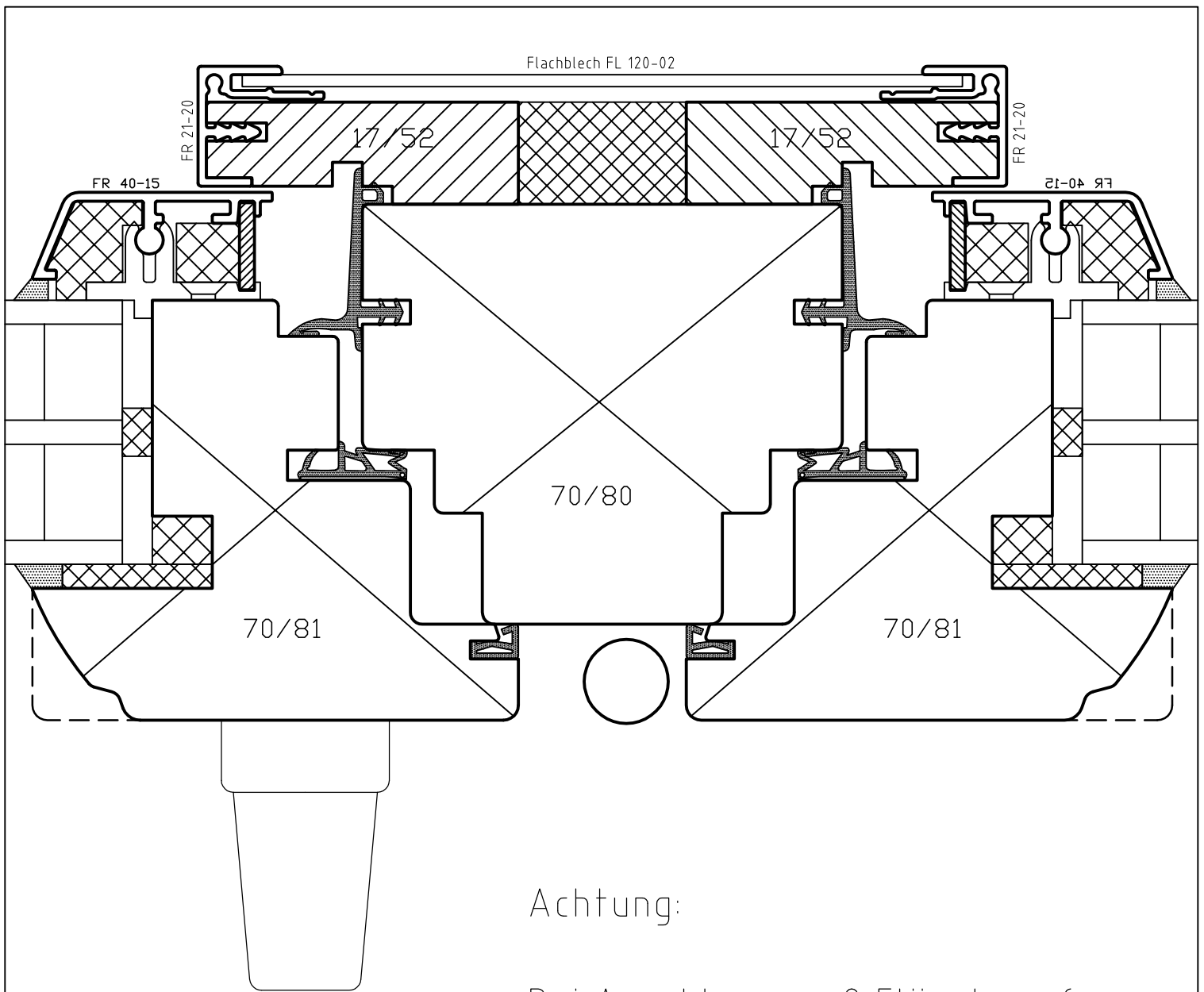



Kommission				Auftragsnr:	STEFANI <small>FENSTER, TÜREN • MÖBEL AUS DEM NENNVERTEIL</small>
Oberfläche		Beschlag			
Behandlung		Sonstiges	Datum 11.2010		
Maßstab: 1:1	Benennung:	CadName: wie Benennung			
<h1>Alu2Holz Setzholz Fix-Flügel</h1>					



Achtung:

Bei Anschlag von 2 Flügeln auf einem Setzholz ist ein gleichzeitiges Öffnen beider Flügel auf 90° nicht möglich!

Anschlagvariante DKL+DKR ebenfalls nicht möglich!

-  Kork
-  Holz
-  Dämmung
-  Dichtung
-  Fensterrahmen
-  Silikon
-  Butylband

Patentrechtlich geschützt!

Kommission				Auftragsnr:	STEFANI <small>FENSTER, TÜREN • NÖBEL AUS DEM NENNVERTEL</small>
Oberfläche		Beschlag			
Behandlung		Sonstiges	Datum 11.2010		
Maßstab: 1:1	Benennung:	CadName: wie Benennung			
<h2>Alu2Holz Setzholz Flügel-Flügel</h2>					